

Mobile Configuration

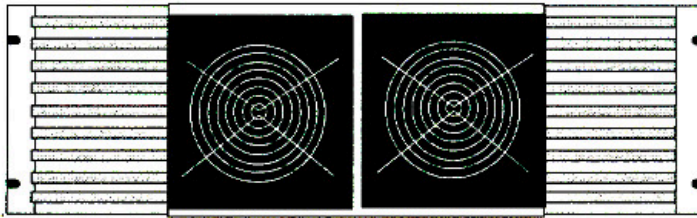

/R Repeater and
/P Paging Configuration

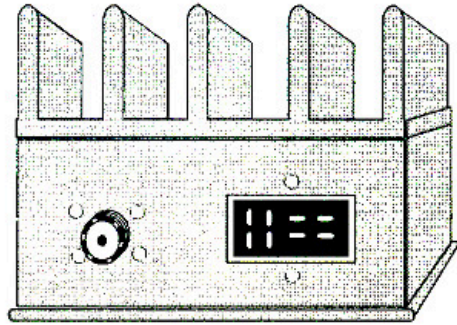
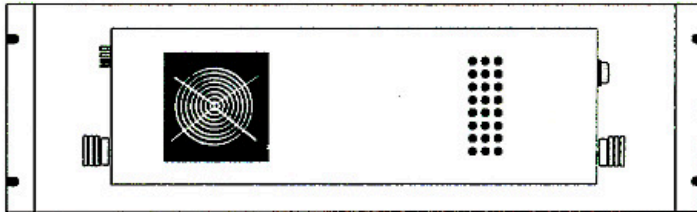

C100D Series Operating and Maintenance Manual

UHF RF POWER AMPLIFIERS

HENRY RADIO, INC.

2050 S. Bundy Drive Los Angeles, CA 90025 USA 310-820-1234 310-826-7790 fax

LIMITED WARRANTY: Henry Radio warrants each new product to be free from defective material and workmanship. Henry Radio agrees to remedy any such defect or to furnish a new part in exchange for any part of any unit which under normal installation, use, and service discloses such defect. The equipment or part must be delivered by the original owner to us intact for our examination, with all transportation charges prepaid to our factory, within 1 year from the date of sale to the original purchaser. Provided that our evaluation discloses, in our judgement, such a defect, Henry Radio will repair at no charge, or replace at their discretion, such defective part or equipment.

EXCLUSIONS: Henry Radio does not warrant any vacuum tube used in their equipment. These are warranted by the tube manufacturer. Warranty claims must include proof of the date of purchase. The warranty does not extend to damage or failure caused by transportation damage, misuse, neglect, accident, incorrect installation, acts of nature, or to equipment modified or repaired without our prior approval.

This warranty does not include incidental or consequential damages and the Henry Radio warranty disclaims any liability for any such damage. All implied warranties, if any, are limited in duration to the above stated 1 year.

Henry Radio reserves the right to make any improvements to its products which it may deem desirable without obligation to install such improvements in its previously sold products.

C100D Series of UHF Power Amplifiers

SPECIFICATIONS

RF Output Power:	100 watts maximum.
RF Input Power:	2 watts nominal (C100D02 models). 10 watts nominal (C100D10 models). 30 watts nominal (C100D30 models).
Frequency Range:	390 to 512 MHz (4 MHz tuned bandwidth).
Input/Output Impedance:	50 ohms nominal.
Harmonic Suppression:	70 dB nominal.
Mode:	Class C (for FM operation).
RF Connectors:	N type (female) or UHF type (female).
Duty Cycle:	Continuous at rated output (/R or /P models), 50% mobile models.
Cooling:	Built-in DC fans with thermostat control (/R or /P).
Power Requirements:	13.8 VDC, negative ground, 30 amps maximum.
Dimensions:	19" wide x 14.5" high x 8" deep (/R or /P models). 13.5" long x 4" wide x 4" high (mobile models).
Shipping Weight:	15 pounds (/R and /P), 5 pounds (mobile models).
Relay:	Bypass dropout (/R), T/R (mobiles), none (/P).
Options:	AC power supply (110 or 220 VAC).
Warranty:	1 year parts and labor.

Made in the USA

INSTALLATION NOTES

INTRODUCTION

Remove the amplifier from its packing material and examine it carefully for damage in shipping. If the amplifier was damaged in shipment, save the box and packing material and notify the transportation company immediately.

The amplifier was tested and tuned at our factory at the operating frequency specified when the order was placed. A description of the frequency and test results is included on an enclosed test sheet. These tests were made into a 50 ohm dummy load.

The installer is responsible to provide the following items:

A 50 ohm antenna tuned to the operating frequency - - An operating location with proper ventilation to prevent overheating - - Output coax to connect the amplifier and antenna that can handle 100+ watts at 450 MHz (RG142, 9913, or hardline) without overheating - - An operating location protected from environmental hazards such as water, heat, pests, or dust - - A stable drive signal at the input jack of the amplifier adjusted to a proper power level.

INSTALLATION

Connect the amplifier to the vehicle power source for mobile operation, or a 13.8 VDC power supply capable of supplying at least 30 amps of power in continuous service for base operation. You must use a wire gauge large enough to prevent voltage drop at high current levels (a minimum of 10 gauge).

Connect your radio or transmitter/repeater to the RF input connector on the amplifier using 50 ohm coax cable.

Connect the amplifier to your antenna or a

50 ohm dummy load on your test bench.

Install a through-line wattmeter in the output cable (either a Bird 43 or equal). Turn on the power source and the transmitter or radio.

Slowly increase the power from your transmitter until the output power of the amplifier reaches the desired level - as shown on the wattmeter.

If you do not have a wattmeter, an alternate method is to use the performance figures shown on the supplied test sheet to approximate the output.

At the operating power level, reverse the wattmeter element and confirm that the reflected power is near zero. If the reflected power is greater than 10% of the output power, your antenna is not properly tuned and you may damage the amplifier!

You can increase reliability and save money by installing proper lightning protection on your base antenna system.

SERVICE AND REPAIR

Should it be necessary to return the amplifier for warranty or non-warranty repair, pack it very carefully to prevent shipping damage.

Be certain to include a written description of the problem, your operating frequency, and any special instructions.

It is wise to call first to make sure it is necessary to return the equipment.

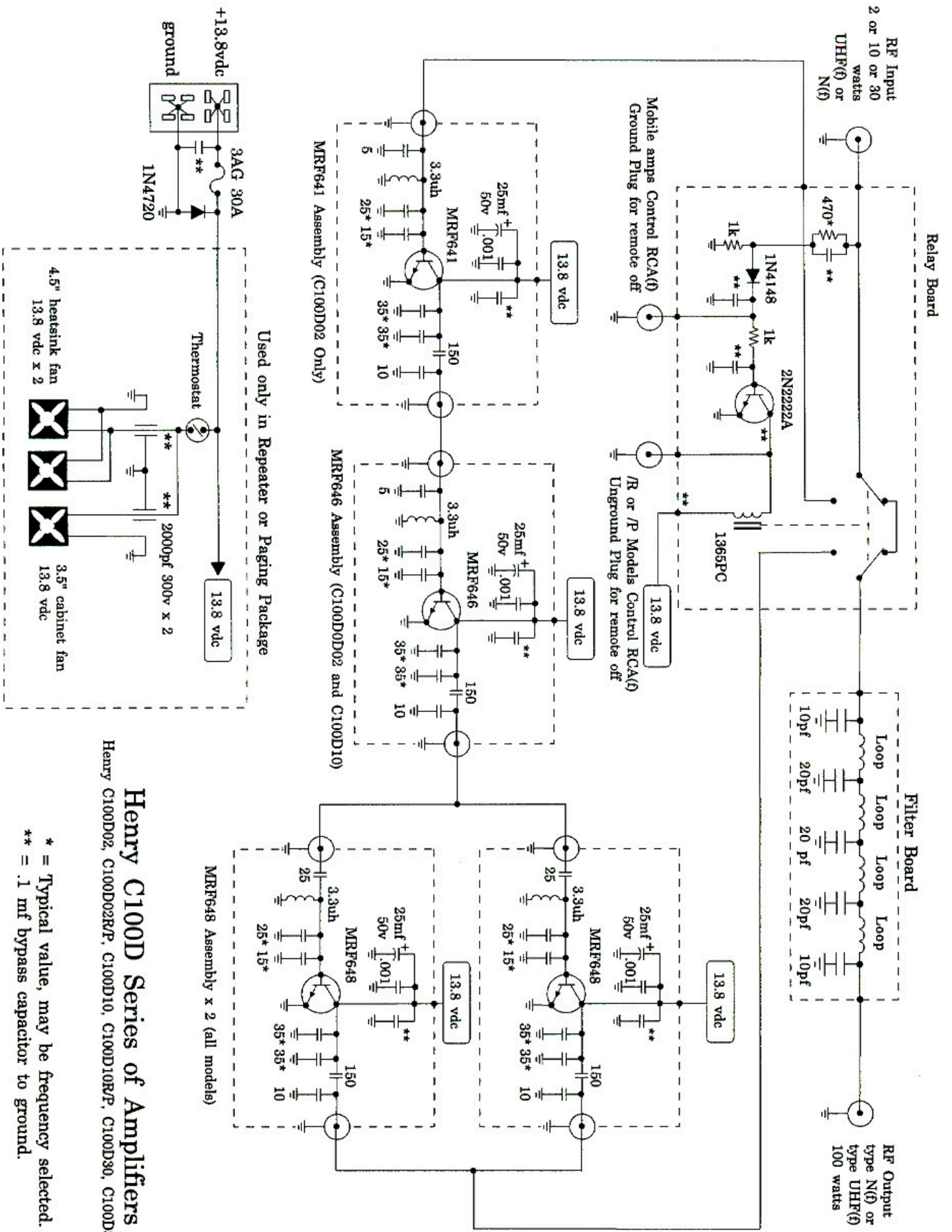

Henry C100D Series of Amplifiers

Henry C100D02, C100D02R/P, C100D10, C100D10R/P, C100D30, C100D30R/P

* = Typical value, may be frequency selected.
 ** = .1 mf bypass capacitor to ground.

INSTALLATION DRAWING

GOOD RELIABILITY REQUIRES:

Stable RF drive at the proper designated wattage.
 A proper power supply, regulated, 13.8 VDC, 30 amps plus.
 Minimum SWR at the output connector.

Professional lightning protection on the antenna.
 Professional lightning protection on the AC mains.
 Proper environmental protection from dust, moisture,
 and heat.
 Proper coax on the antenna line.

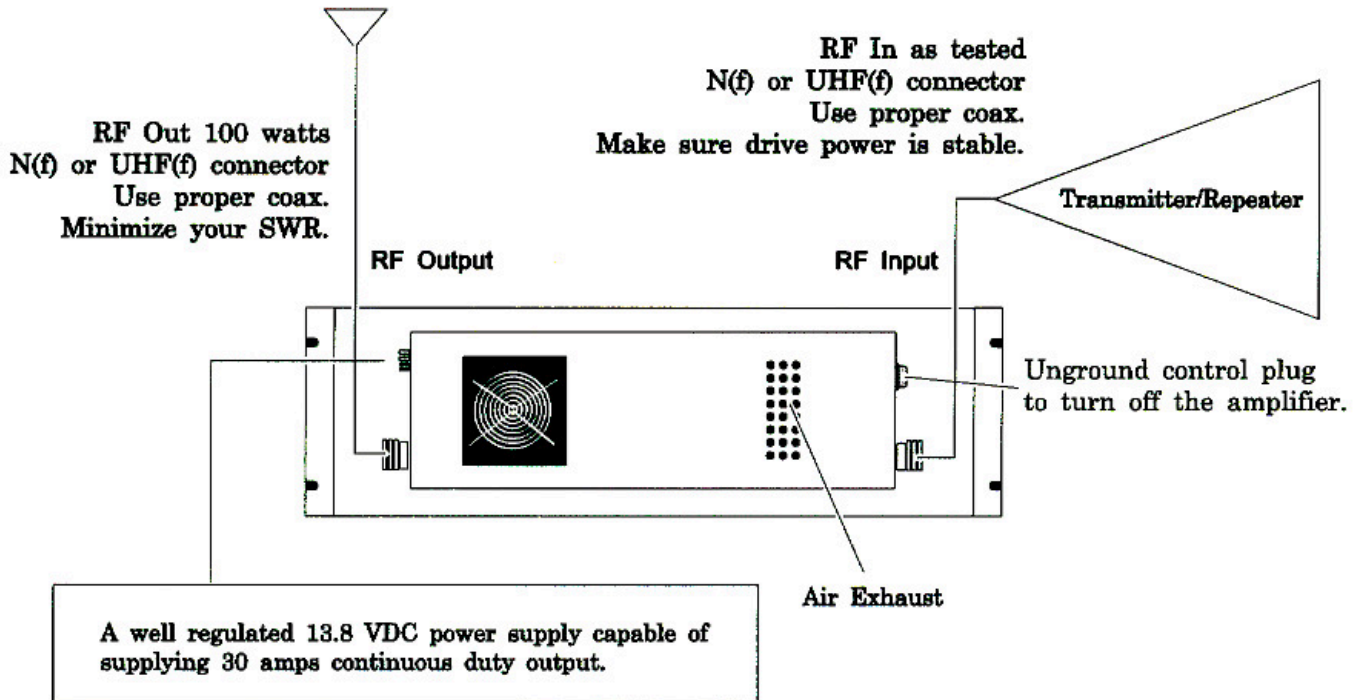

GOOD RELIABILITY REQUIRES:

Stable RF drive at the proper designated wattage.
 A proper connection to the 13.8 VDC battery system.
 Minimum SWR at the output connector.

Use 10 gauge DC cable or larger.
 Proper environmental protection from dust, moisture,
 and heat.
 Proper coax on the antenna line.

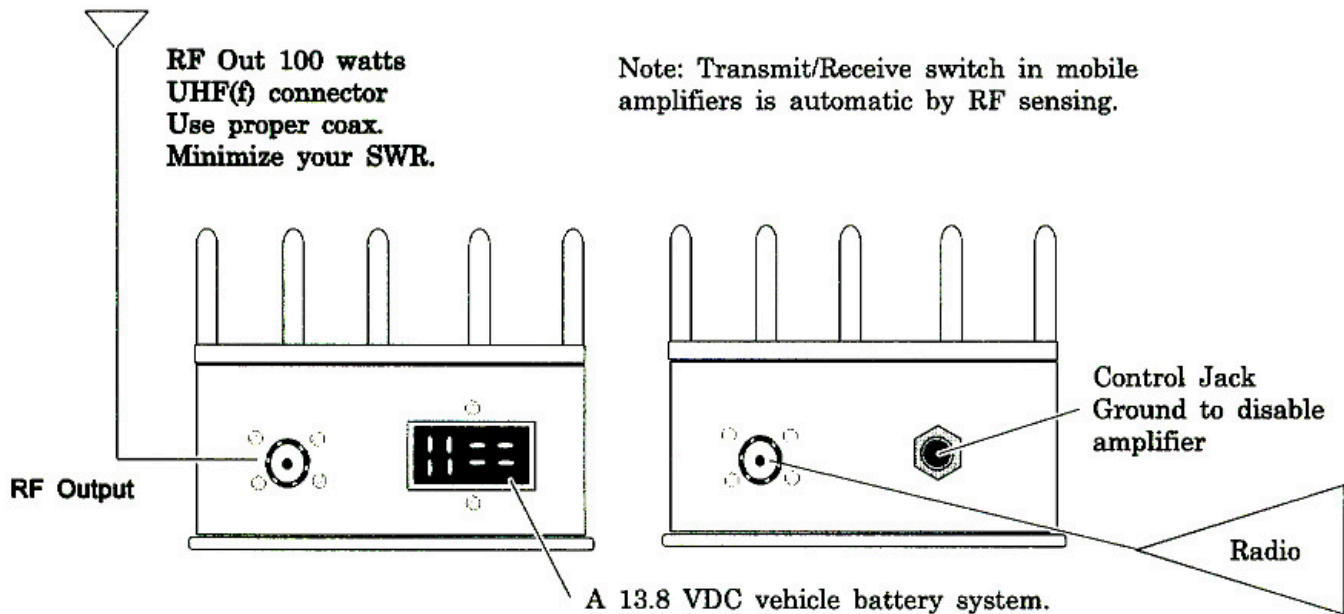

Henry 9600-1075

RF Power Amplifier Module – UHF – 150-200 mw to 10 watts

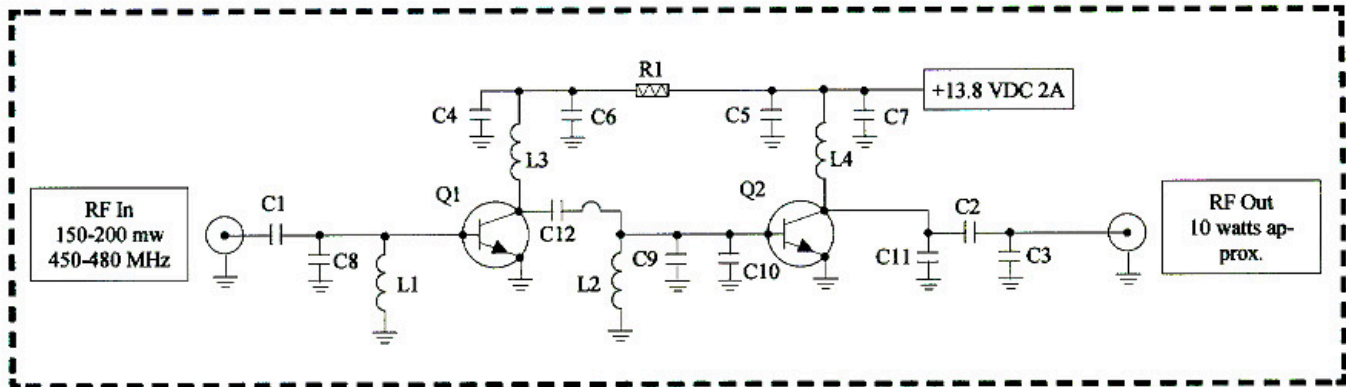

Schematic No.	Description	Part Number
C1-C2	Capacitor: Mica chip, miniature, 200 pf, 125 vdc.	Capacitor
C3	Capacitor: Mica chip, miniature, 10 pf, 125 vdc.	Capacitor
C4-C5	Capacitor: Bypass, .1 mf, 25 vdc.	Capacitor
C6-C7	Capacitor: Electrolytic, bypass, 10 mf, 25 vdc.	Capacitor
C8-C9-C10-C11	Capacitor: Mica chip, miniature, 27 pf, 125 vdc.	Capacitor
C12	Capacitor: Mica chip, miniature, 15 pf, 125 vdc.	Capacitor
L1-L2	Choke: Encapsulated, 1 microhenry, miniature.	Miller 9230-20
L3-L4	Coil: 4 turn open buss wire.	Henry
Q1	Transistor: Bipolar, RF power amplifier, UHF.	Motorola MRF555
Q2	Transistor: Bipolar, RF power amplifier, UHF.	Motorola MRF641
R1	Resistor: Wire wound 10 ohm, 3 watt, 1%.	Resistor

All specifications and part numbers are subject to change without notice.

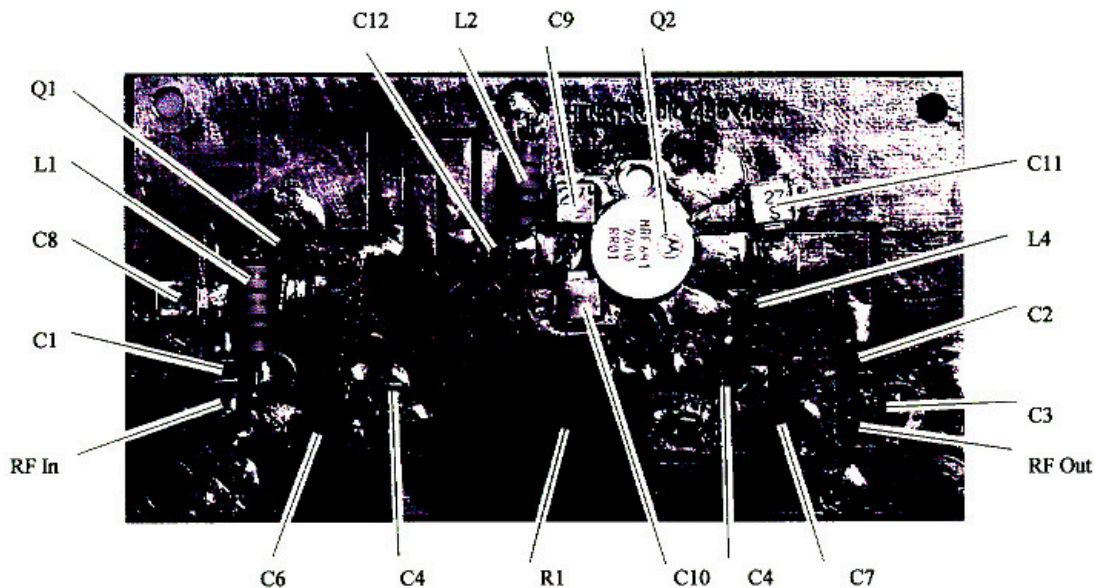

Henry C100D Series Chassis Diagram

Repeater Configuration

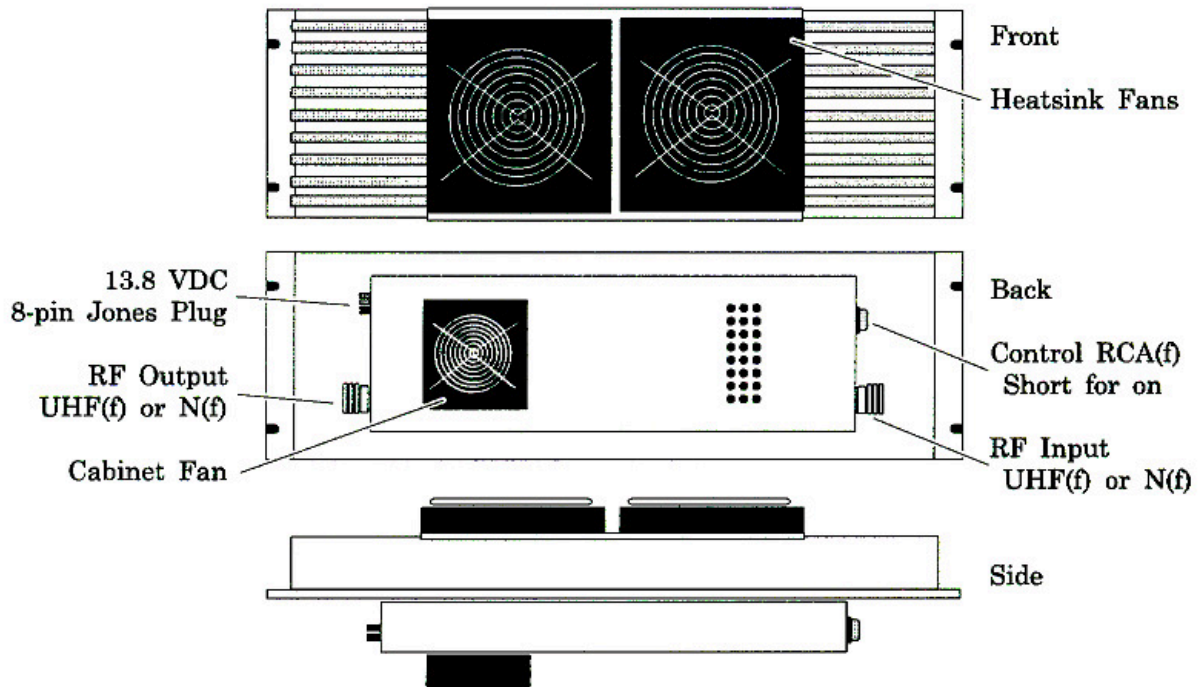

Mobile Configuration

